

Foundations of Computer Science

Lecture 15

Probability

Computing Probabilities

Probability and Sets: Probability Space

Uniform Probability Spaces

Infinite Probability Spaces

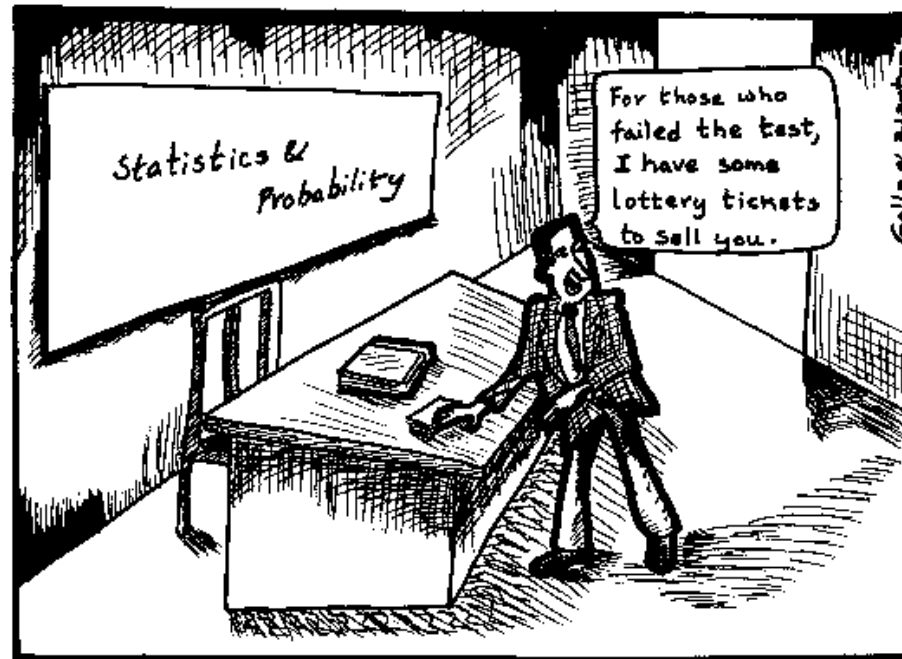

The probable is what usually happens – Aristotle

To count complex objects, construct a sequence of “instructions” that can be used to construct the object uniquely. The number of possible *sequences* of instructions equals the number of possible complex objects.

① Counting

- ▶ Sequences with and without repetition.
- ▶ Subsets with and without repetition.
- ▶ Sequences with specified numbers of each type of object: anagrams.

② Inclusion-Exclusion (advanced technique).

③ Pigeonhole principle (simple but IMPORTANT technique).

Today: Probability

1 Computing probabilities.

- Outcome tree.
- Event of interest.
- Examples with dice.

2 Probability and sets.

- The probability space.

3 Uniform probability spaces.

4 Infinite probability spaces.

The Chance of Rain Tomorrow is 40%

What does the title mean? Either it will rain tomorrow or it won't.

The chances are 50% that a *fair* coin-flip will be H.

Flip 100 times. Approximately 50 will be H

← *frequentist* view.

- 1 You toss a *fair* coin 3 times. How many heads will you get?
- 2 You keep tossing a *fair* coin until you get a head. How many tosses will you make?

There's no answer. The outcome is uncertain. Probability handles such settings.

Birth of Mathematical Probability.

Antoine Gombaud,: Should I bet even money on at least one 'double-6' in 24 rolls of two dice?

Chevalier de Méré What about at least one 6 in 4 rolls of one die?

Blaise Pascal: Interesting question. Let's bring *Pierre de Fermat* into the conversation.

... a correspondence is ignited between these two mathematical giants

Toss Two Coins: You Win if the Coins Match (HH or TT)

1 You are analyzing an “experiment” whose outcome is uncertain.

2 **Outcomes.** Identify all *possible* outcomes using a *tree* of outcome *sequences*.

3 **Edge probabilities.** If one of k edges (options) from a vertex is chosen *randomly* then each edge has edge-probability $\frac{1}{k}$.

4 **Outcome-probability.** Multiply edge-probabilities to get outcome-probabilities.

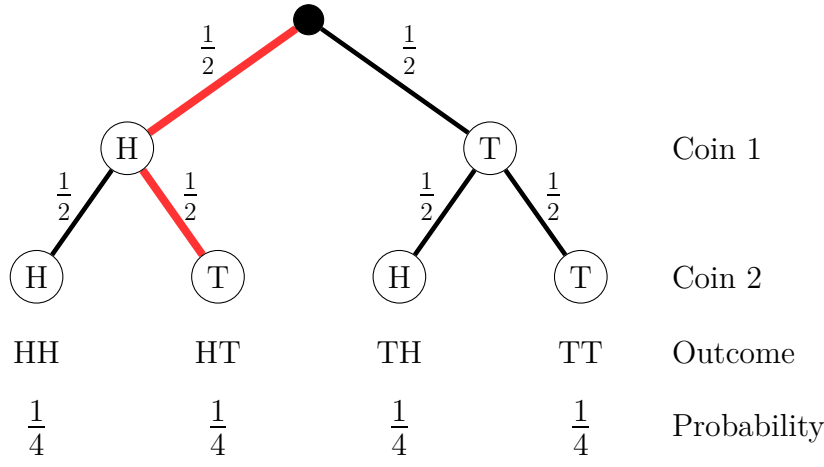

Event of Interest

Toss two coins: you win if the coins match (HH or TT)

Question: When do you win?

Event: *Subset* of outcomes where you win.

5 **Event of interest.** Subset of the outcomes where you win.

6 **Event-probability.** Sum of its outcome-probabilities.

$$\text{event-probability} = \frac{1}{4} + \frac{1}{4} = \frac{1}{2}.$$

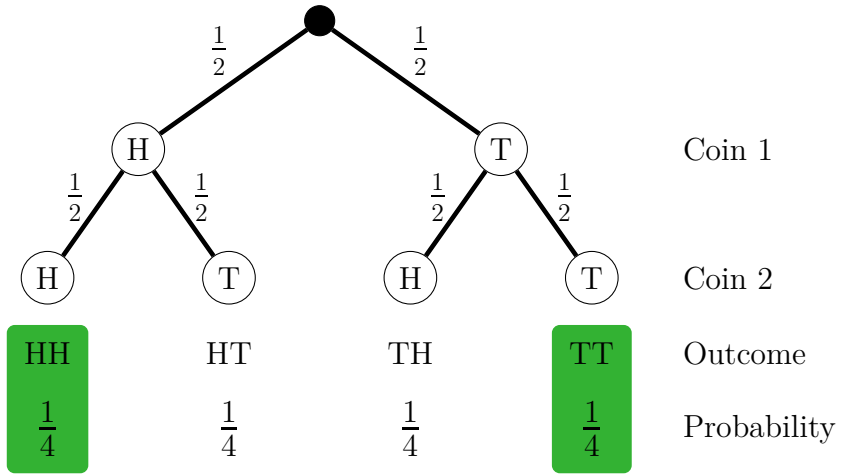

Probability that you win is $\frac{1}{2}$, written as $\mathbb{P}[\text{“YouWin”}] = \frac{1}{2}$.

Go and do this experiment at home. Toss two coins 1000 times and see how often you win.

The Outcome-Tree Method

Become familiar with this 6-step process for analyzing a probabilistic experiment.

- 1 You are analyzing an experiment whose outcome is uncertain.
- 2 **Outcomes.** Identify *all possible* outcomes, the tree of *outcome sequences*.
- 3 **Edge-Probability.** Each edge in the outcome-tree gets a probability.
- 4 **Outcome-Probability.** Multiply edge-probabilities to get outcome-probabilities.
- 5 **Event of Interest \mathcal{E} .** Determine the subset of the outcomes you care about.
- 6 **Event-Probability.** The sum of outcome-probabilities in the subset you care about.

$$\mathbb{P}[\mathcal{E}] = \sum_{\text{outcomes } \omega \in \mathcal{E}} P(\omega).$$

$\mathbb{P}[\mathcal{E}] \sim$ frequency an outcome you want occurs over many repeated experiments.

Pop Quiz. Roll two dice. Compute \mathbb{P} [first roll is less than the second].

Let's Make a Deal: The Monty Hall Problem

- 1: Contestant at door 1.
- 2: Prize placed behind *random* door.
- 3: Monty opens empty door (*randomly* if there's an option).

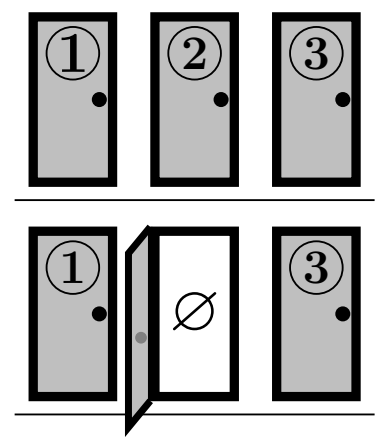

- Outcome-tree and edge-probabilities.
- Outcome-probabilities.
- Event of interest: “WinBySwitching”.
- Event probability.

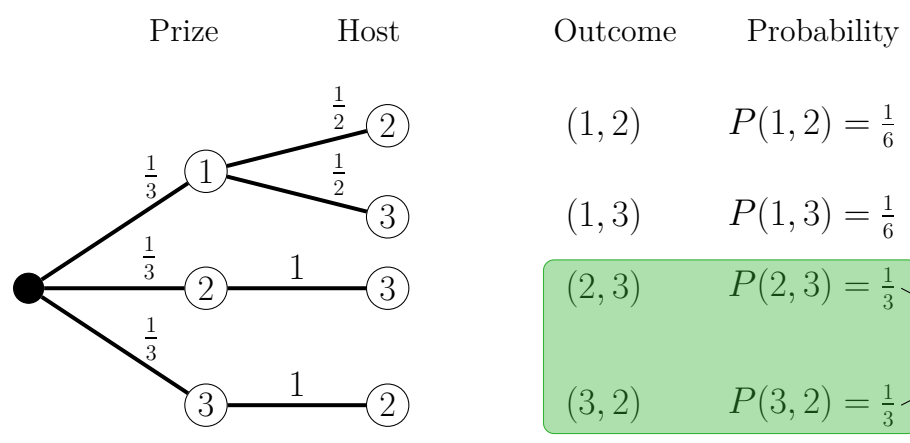

$$\frac{1}{3} + \frac{1}{3} = \frac{2}{3} = \mathbb{P}[\text{“WinBySwitching”}]$$

Non-Transitive Dice

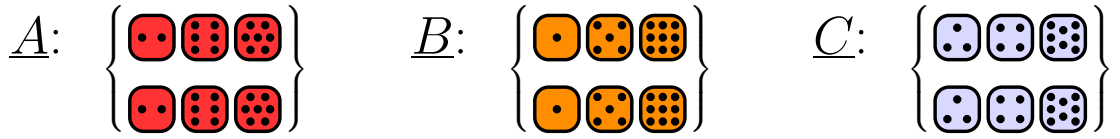

Your friend picks a die and then you pick a die.
 E.g. friend picks B and then you pick A .

What is the probability that A beats B ?

- Outcome-tree and outcome-probabilities.
- Uniform probabilities.
- Even of interest: outcomes where A wins.
- Number of outcomes where A wins: 5.
- $\mathbb{P}[A \text{ beats } B] = \frac{5}{9}$.

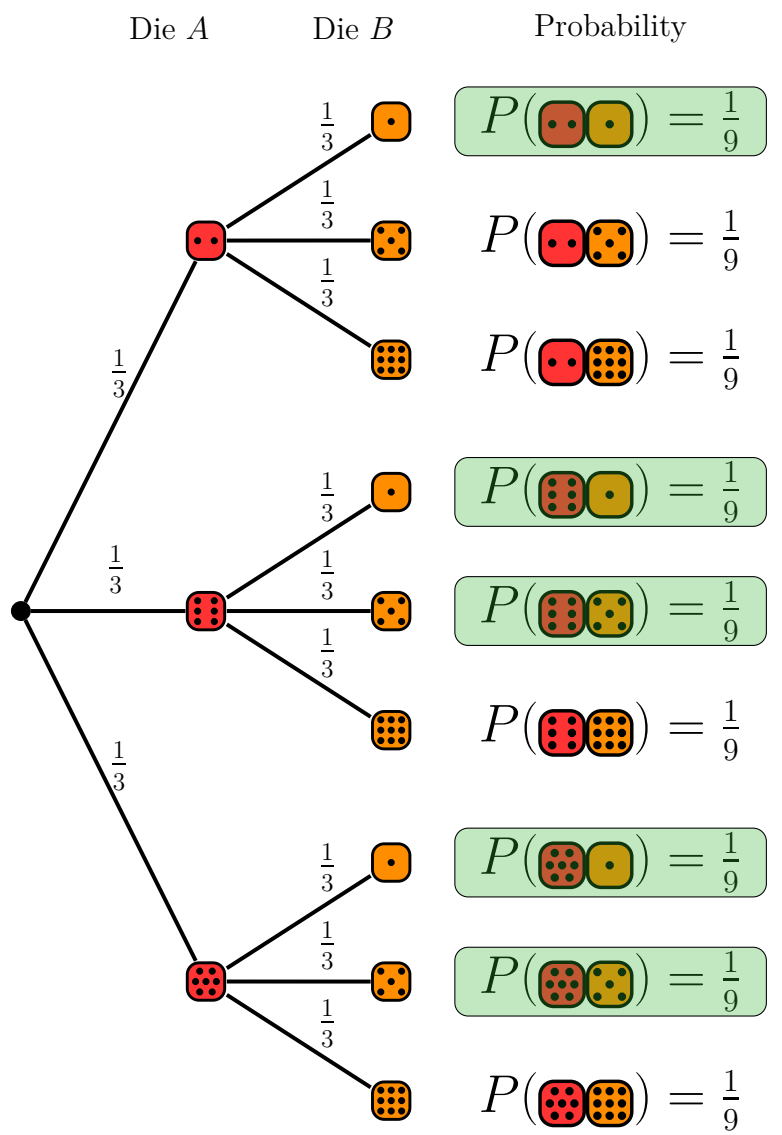

Conclusion: Die A beats Die B .

Pop Quiz. Compute $\mathbb{P}[B \text{ beats } C]$ and $\mathbb{P}[C \text{ beats } A]$ and show A beats B , B beats C and C beats A .

Probability and Sets: The Probability Space

1 Sample Space $\Omega = \{\omega_1, \omega_2, \dots\}$, set of *possible* outcomes.
2 Probability Function $P(\cdot)$. Non-negative function $P(\omega)$, normalized to 1:

$$0 \leq P(\omega) \leq 1 \quad \text{and} \quad \sum_{\omega \in \Omega} P(\omega) = 1.$$

(Die A versus B)

Ω	{										}
$P(\omega)$		$\frac{1}{9}$	$\frac{1}{9}$	$\frac{1}{9}$	$\frac{1}{9}$	$\frac{1}{9}$	$\frac{1}{9}$	$\frac{1}{9}$	$\frac{1}{9}$	$\frac{1}{9}$	}

Events $\mathcal{E} \subseteq \Omega$ are subsets. Event probability $\mathbb{P}[\mathcal{E}]$ is the sum of outcome-probabilities.

- “ $A > B$ ” $\mathcal{E}_1 = \{ \text{Die A: 2, Die B: 1}, \text{Die A: 3, Die B: 1}, \text{Die A: 3, Die B: 2}, \text{Die A: 4, Die B: 1}, \text{Die A: 4, Die B: 2} \}$
- “Sum > 8 ” $\mathcal{E}_2 = \{ \text{Die A: 3, Die B: 3}, \text{Die A: 4, Die B: 2}, \text{Die A: 4, Die B: 3}, \text{Die A: 5, Die B: 2}, \text{Die A: 5, Die B: 3} \}$
- “ $B < 9$ ” $\mathcal{E}_3 = \{ \text{Die A: 1, Die B: 1}, \text{Die A: 1, Die B: 2}, \text{Die A: 2, Die B: 1}, \text{Die A: 2, Die B: 2}, \text{Die A: 3, Die B: 1}, \text{Die A: 3, Die B: 2} \}$

Combining events using logical connectors corresponds to set operations:

- “ $A > B$ ” \vee “Sum > 8 ” $\mathcal{E}_1 \cup \mathcal{E}_2 = \{ \text{Die A: 2, Die B: 1}, \text{Die A: 3, Die B: 1}, \text{Die A: 3, Die B: 2}, \text{Die A: 4, Die B: 1}, \text{Die A: 4, Die B: 2}, \text{Die A: 3, Die B: 3}, \text{Die A: 4, Die B: 3}, \text{Die A: 5, Die B: 2}, \text{Die A: 5, Die B: 3} \}$
- “ $A > B$ ” \wedge “Sum > 8 ” $\mathcal{E}_1 \cap \mathcal{E}_2 = \{ \text{Die A: 3, Die B: 2}, \text{Die A: 4, Die B: 2} \}$
- \neg (“ $A > B$ ”) $\overline{\mathcal{E}_1} = \{ \text{Die A: 1, Die B: 1}, \text{Die A: 1, Die B: 2}, \text{Die A: 2, Die B: 1}, \text{Die A: 2, Die B: 2}, \text{Die A: 3, Die B: 1}, \text{Die A: 3, Die B: 2} \}$
- “ $A > B$ ” \rightarrow “ $B < 9$ ” $\mathcal{E}_1 \subseteq \mathcal{E}_3$

Important: Exercise 15.10. Sum rule, complement, inclusion-exclusion, union, implication and intersection bounds.

Uniform Probability Space : Probability \sim Size

$$P(\omega) = \frac{1}{|\Omega|} \qquad \mathbb{P}[\mathcal{E}] = \frac{|\mathcal{E}|}{|\Omega|} = \frac{\text{number of outcomes in } \mathcal{E}}{\text{number of possible outcomes in } \Omega}.$$



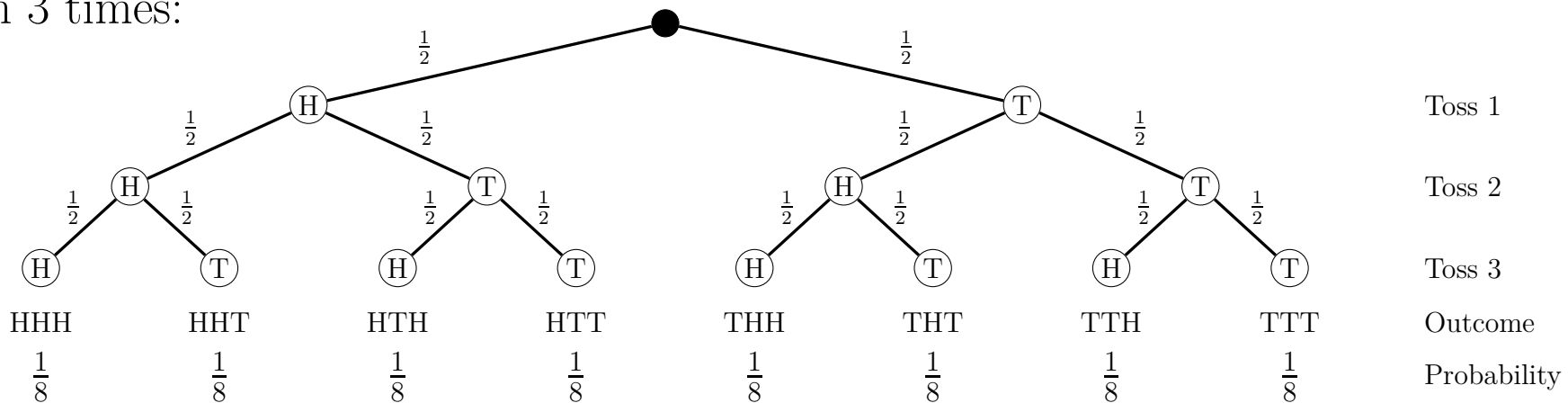

Toss a coin 3 times:



$$\mathbb{P}[\text{"2 heads"}] = \frac{\text{number of sequences with 2 heads}}{\text{number of possible sequences in } \Omega} = \binom{3}{2} \times \frac{1}{8} = \frac{3}{8}.$$

- Practice: Exercise 15.10.**
- ① You roll a pair of regular dice. What is the probability that the sum is 9?
 - ② You toss a fair coin ten times. What is the probability that you obtain 4 heads?
 - ③ You roll die *A* ten times. Compute probabilities for: 4 sevens? 4 sevens AND 3 sixes? 4 sevens OR 3 sixes?

Poker: Probabilities of Full House and Flush

52 card deck has 4 suits (, , , ) and 13 ranks in a suit (A,K,Q,J,T,9,8,7,6,5,4,3,2).

Randomly deal 5-cards: each *set* of 5 cards is equally likely \rightarrow uniform probability space.

number of possible outcomes = $\binom{52}{5}$ possible hands.

Full house: 3 cards of one rank and 2 of another. How many full-houses?

To construct a full house, specify (**rank₃, suits₃, rank₂, suits₂**). Product rule:

$$\# \text{ full houses} = 13 \times \binom{4}{3} \times 12 \times \binom{4}{2} \quad \rightarrow \quad \mathbb{P}[\text{“FullHouse”}] = \frac{13 \times \binom{4}{3} \times 12 \times \binom{4}{2}}{\binom{52}{5}} \approx 0.00144;$$

Flush: 5 cards of same suit. How many flushes?

To construct a flush, specify (**suit, ranks**). Product rule:

$$\# \text{ flushes} = 4 \times \binom{13}{5} \quad \rightarrow \quad \mathbb{P}[\text{“Flush”}] = \frac{4 \times \binom{13}{5}}{\binom{52}{5}} \approx 0.00198;$$

Full house is rarer. That's why full house beats flush.

Toss a Coin Until Heads: Infinite Probability Space

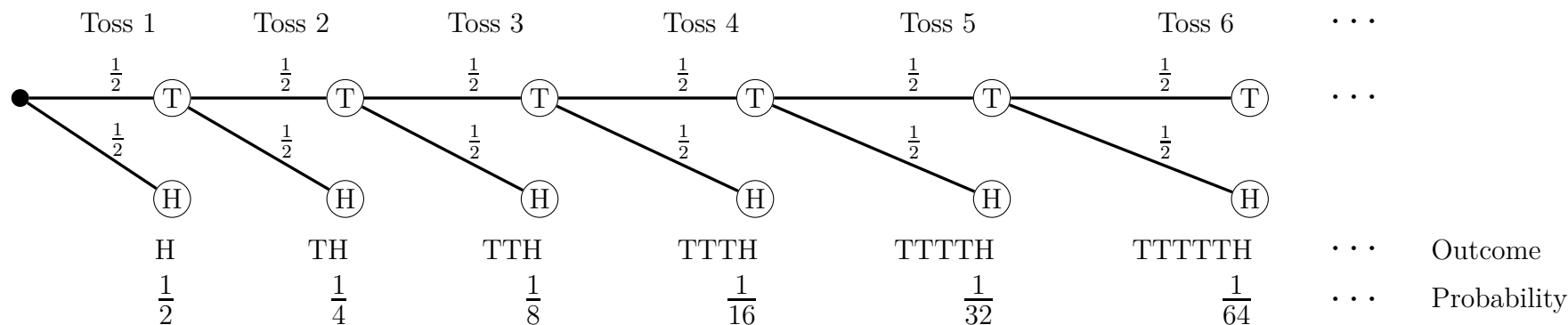

Ω	H	TH	$T^{\bullet 2}H$	$T^{\bullet 3}H$	$T^{\bullet 4}H$	$T^{\bullet 5}H$...	$T^{\bullet i}H$...
$P(\omega)$	$\frac{1}{2}$	$(\frac{1}{2})^2$	$(\frac{1}{2})^3$	$(\frac{1}{2})^4$	$(\frac{1}{2})^5$	$(\frac{1}{2})^6$...	$(\frac{1}{2})^{i+1}$...
# Tosses	1	2	3	4	5	6	...	$i + 1$...

Sum of outcome probabilities:

$$\frac{1}{2} + \left(\frac{1}{2}\right)^2 + \left(\frac{1}{2}\right)^3 + \left(\frac{1}{2}\right)^4 + \dots = \sum_{i=1}^{\infty} \left(\frac{1}{2}\right)^i = \frac{\frac{1}{2}}{1 - \frac{1}{2}} = 1. \checkmark$$

Game: First Person To Toss H Wins. Always Go First

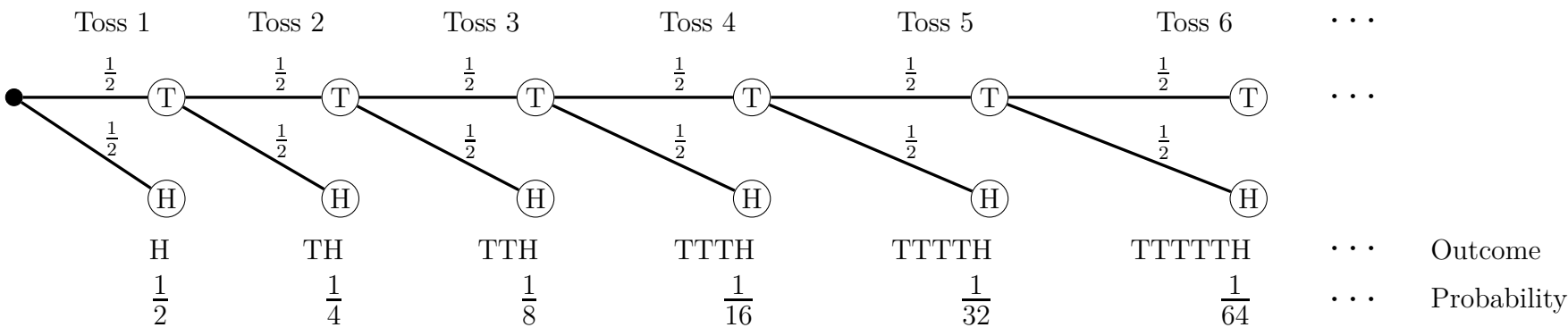

Ω	H	TH	$T^{\bullet 2}H$	$T^{\bullet 3}H$	$T^{\bullet 4}H$	$T^{\bullet 5}H$...	$T^{\bullet i}H$...
$P(\omega)$	$\frac{1}{2}$	$(\frac{1}{2})^2$	$(\frac{1}{2})^3$	$(\frac{1}{2})^4$	$(\frac{1}{2})^5$	$(\frac{1}{2})^6$...	$(\frac{1}{2})^{i+1}$...

The event "YouWin" is $\mathcal{E} = \{H, T^{\bullet 2}H, T^{\bullet 4}H, T^{\bullet 6}H, \dots\}$.

$$\mathbb{P}[\text{"YouWin"}] = \frac{1}{2} + (\frac{1}{2})^3 + (\frac{1}{2})^5 + (\frac{1}{2})^7 + \dots = \frac{1}{2} \sum_{i=0}^{\infty} (\frac{1}{4})^i = \frac{\frac{1}{2}}{1 - \frac{1}{4}} = \frac{2}{3}$$

Your odds improve by a factor of 2 if you go first (vs. second).